

# User Manual

## 3.5 inch Wireless Video Door Phone



# Directory

<b>1. Introduction</b> .....	1
<b>1.1. Safety Warning &amp; Attentions</b> .....	1
<b>1.2. Product Diagram</b> .....	2
<b>1.3. Performance parameters</b> .....	3
<b>2. Installation Guide</b> .....	4
<b>3. Instructions</b> .....	6
<b>3.1. Turn on/off</b> .....	6
<b>3.2. Keys' functions of indoor unit</b> .....	6
<b>3.3. UI Operation Instruction</b> .....	6
<b>3.4. Communication Instruction</b> .....	7
<b>3.4.1. Intercom between outdoor unit and indoor unit</b> .....	7
<b>3.4.2. Intercom between indoor units</b> .....	8
<b>3.5. Pairing operation steps</b> .....	8
<b>3.5.2. 1V2 - Match code</b> .....	8
<b>3.5.3. 1V3 - Match code</b> .....	8
<b>3.5.4. Add one more outdoor unit - Match code</b> .....	8
<b>4. Configuration</b> .....	9
<b>5. General faults and solutions</b> .....	9

## 1. Introduction

- Thank you for choosing this wireless video door phone. Please read this Manual carefully to fully understand its usage, perfect functions and simple operation.
- Before using this product, please read these Attentions carefully to ensure safe and proper operation of this product.
- The Company reserves the right to modify this Manual from time to time without prior notice.

### 1.1. Safety Warning & Attentions

- Do not place this product on an uneven or unstable table-board to prevent failure or damage caused by falling.
- Only the battery and charger designated by the Company can be used on this product. Application of other products may lead to leakage, overheating, blowout and fire of the battery.
- Do not violently strike, shake or toss the wireless video door phone to prevent failure and fire caused to the wireless video door phone.
- Do not put battery, charger or wireless video door phone in the microwave oven or high-pressure device; otherwise, damage and fire of electrical circuit and other accidents may be caused.
- Do not use this product in a place with flammable and explosive gas; otherwise, product failure and fire may be caused.
- Do not place this product in a place with high temperature, high humidity or large amount of dust; otherwise, product failure may be caused.
- Do not dismantle or remodel this product, otherwise, damage, creepage and electrical fault may be caused.
- Place tiny metal objects such as drawing pin at a place far away from the speaker. As the speaker has magnetic property while working, it will attract these tiny metal objects, which may lead to personal injuries or damage of the speaker.
- Do not project the lens at strong light source, such as the sun; otherwise, damage of the image sensor may be caused.
- Do not press the terminal of lens with much force; otherwise, personal injury or damage of the device may be caused.
- If this product is made wet by mistake, shut it down, remove the battery, and restart the product after confirming it complete dry after 24 hours.
- Use clean and dry soft cloth to clean the lens, infrared lamp and light sensor.
- **Warning: improper operation will void warranty!!**

## 1.2.Product Diagram

Outdoor Unit:



Indoor Unit:



### 1.3. Performance parameters

Outdoor unit	Power	Specific lithium battery (3400mAh)
	Consumption	400mA
	Outline dimension	134*74*31mm
	Weight	122g
	Environmental condition	Temperature: -10℃~+50℃
	Waterproof grade	IP55
	Placement	Hang on out wall
	Surface material	ABS & hardware accessories
	Camera	300,000pixels
	View angle	120° wide angle (Extra 15° adjustable)
	Night vision pattern	Infrared lamps
	PIR	3M*100°
	Working time	3hours continuously
	Standby time	300hours
Charge time	3hours	
External power	AC9~16V/DC5~16V	

Indoor monitor	Power	Specific lithium battery BP-6M(1100mAh)
	Consumption	400mA
	Outline dimension	126*84*20mm
	Weight	110g
	Environmental condition	Temperature: -0℃~+40℃
	Placement	Table style
	LCD size	3.5" TFT color screen
	Wireless communication mode	2.4GHz
	Images spread	25fps
	Picture format	JPEG
	Working time	3hours continuously
	Standby time	300hours
	Charge time	3hours
	External power	DC5V 1A
Application distance	About 300m in open space	

## 2. Installation Guide

1. Outdoor unit shall be installed at 1.4~1.7 meter above the floor, and avoid facing the sunlight directly. Please do not install on the metal wall, metal door or metal plate, which influence the transmission signal.

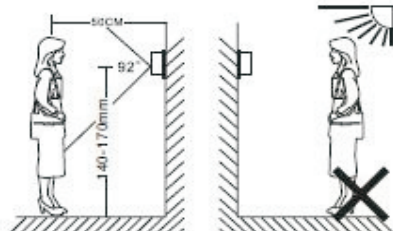

### 2. Installation steps

A. Fix the rain cover on the wall with screws.

B. Put the outdoor unit into rain cover, and install the screw at the bottom.

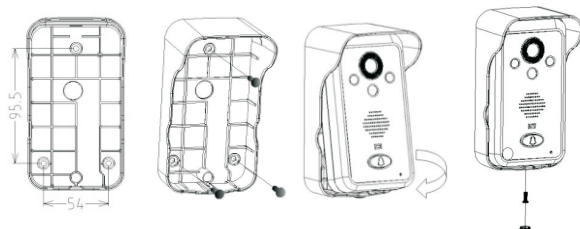

3. Connect DC line according to the wiring diagram (the diameter of hole for wire getting through should be 16~30mm). Red wire (positive pole) connects to point 1; black wire (negative pole) connects to point 2. If powered by AC power, connect wire to point 1 and point 2.

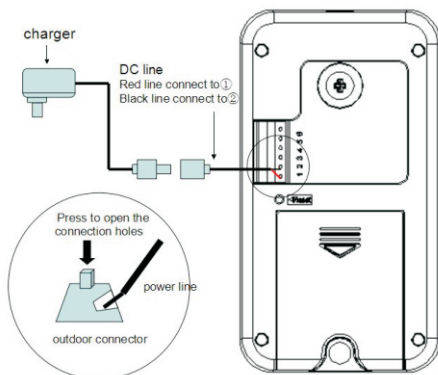

4. Electronic lock and power supply connection, as show below:

If electric lock maintains always open: connect to point 4

If electric lock maintains always close: connect to point 5

Two power lines of lock: one connects to lock, one connects point 6.

**Note: electric lock and power supply should be prepared by user.**

Camera Wiring Diagram

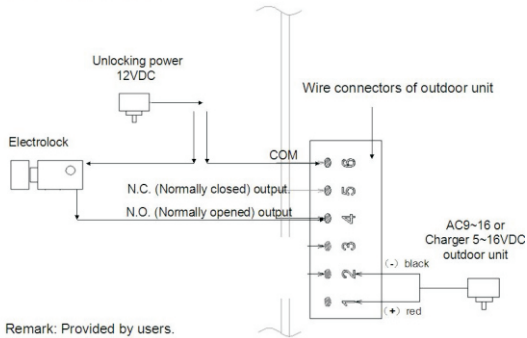

Remark: Provided by users.

5. The camera lens can be adjustable

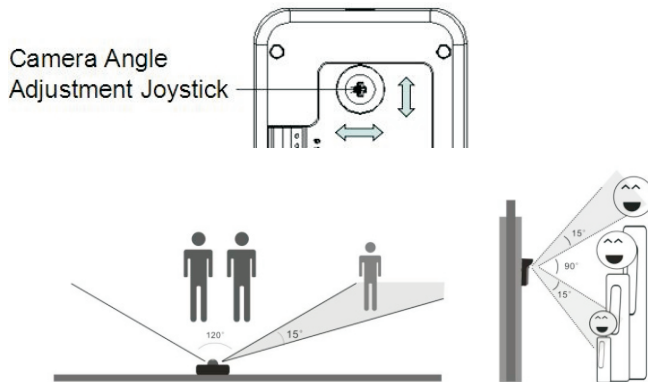





### 3. Instructions

#### 3.1. Turn on/off

- Outdoor unit: Install the battery to turn on. Take out the battery to turn off.(DC/AC9-16V,Lithium battery)
- Indoor Unit: BP-6M Lithium battery,USB charging. Press the “on/off” key for about 3S to turn on. And press the “on/off” key for about 3S to enter shutdown interface: select“Yes” to turn off.

#### 3.2. Keys’ functions of indoor unit

-  off-hook/on-hook and confirm
-  Up option,adjust volume of out door unit
-  Down option,take photo
-  Right option,menu,unlock
-  Exit,monitor
- “ON/OFF” Turn on/off device
- Volume key(+/-) Adjust volume of indoor unit

#### 3.3. UI Operation Instruction

##### Press “MENU Key”, enter main menu



**View&delete photo record.** Can store 240pcs photos. “A” means automatically taking photos. “M” means manual taking photos. “P” means motion sensor photos. “T” means alarm photos. Will automatically cover the earliest photo when memory is full.



**Message for missed call.** Will have the message if miss any call or ring. Can keep 10 messages at most. The message with photo(automatically taking photo) . Automatically cover the earliest message when more than 10 messages. It will not have new message if indoor unit is shutdown or power off.



**Time&date setting.** Can set time,date.For example,12:00 01-12-2018.





**Ring setting.** There are 7 rings. You can select the ring as you like. Meanwhile, can adjust the ring volume by pressing “+” key. Volume have 6 levels.



**Language selection.** English, Spanish, Germany, French, Dutch, Italian, Chinese, 7 languages. Factory default language is English.















**Setting. Enter settings**

- A. Motion detection. Open PIR or turn off.
- B. Backlight time. Setting backlight time from 10-60s, 5s per level, total 10 levels.
- C. Ring time. Setting the ring time from 10-30s, 10s per level, total 3 levels.
- D. Paring: give code, receive code
- E. Version: show the firmware version number.

### 3.4. Communication Instruction

#### 3.4.1. Intercom between outdoor unit and indoor unit.





- A. Press “Call” key on out door unit-indoor unit will ring-show  on screen-press “OK” key to answer the call-will show  on screen. Can be able to intercom.
- B. During intercom, press  key, intercom without sound, and show  on screen.
- C. During intercom, press  key to take video. Will show  on screen.
- D. During intercom, press  key to take photo record, and show  on screen.
- E. Press “+ -” key to adjust volume of indoor nit, and show  on screen.
- F. Adjust volume of outdoor unit. During intercom, press  key to adjust the volume of out door unit.
- G. During intercom, show  on indoor unit screen, the below battery iron is for outdoor unit power, it will be red color when low power.
- H.  the number stands for different indoor unit. The green lines stands for intercom signal.
- I. When stand by, press  key to monitor outside.

J. PIR: when turn on the motion sensor, outdoor unit camera sense person within 2 meters and will take 3pcs photos record automatically. Motion sensor icon 

K. Anti-tamper alarm of outdoor unit. When rain cover separate from device, it will alarm with big sound. At the same time, will take 5pcs photos record. Will show  on screen.

### 3.4.2. Intercom between indoor units.

A. If there are only 2 indoor units, press  key, and can call another indoor unit.

B. If there are 3 indoor units, to call another 2 indoor units. Press  key to call the smaller ID no. indoor unit. Press  key to call the bigger ID no. indoor unit. (for example, to call ID2 indoor unit, press . To call ID3 indoor unit, press  key.)



## 3.5. Pairing operation steps

### 3.5.1. 1V1 Match code (put outdoor unit next to the Indoor monitor)



- Select "code" in setting on indoor monitor -- press  key -- enter into the match code mode.
- Meanwhile, long press the "Reset hole" on outdoor unit back, until you hear one "Beep" sound, then release.
- When indoor monitor displays "Successful", outdoor unit have "di-di-di" three sounds, means matching successfully.
- If matching failed in 16 seconds, indoor monitor shows "failed", the outdoor unit makes "di" sound. Please try above steps again.

NOTE: By default, the monitor is paired well with the outdoor unit.

### 3.5.2. 1V2 - Match code

- Select "Give code" on the 1st paired indoor monitor -- press  key -- enter into the giving code mode.
- On the new (second) indoor monitor, select "receive code" -- press  key. It will have "di-di-di" three sounds, and displays "Successful" on the screen, which means matching the 2nd monitor ok.

### 3.5.3. 1V3 - Match code

- Select "Give code" on the 2nd paired indoor monitor -- press  key -- enter into the giving code mode.
- On the new (third) indoor monitor, select "receive code" -- press  key. It will have "di-di-di" three sounds, and displays "successful" on the screen, which means matching the 3rd monitor ok.

### 3.5.4. Add one more outdoor unit - Match code

- Select "Give code" on any one paired indoor monitor -- press  key -- enter into giving code mode.
- On the new (second) outdoor unit: Long press the "reset" hole until you hear "di-di," two sounds. If match successfully, outdoor unit will have "di-di-di" three sounds, and means adding the 2nd outdoor unit ok.

- After matching ok, please use the No. 2 outdoor unit to call all indoor monitors for testing. if not ok, please repeat the above steps again.

## 4. Configuration

- Manual --1
- Rain cover --1
- Outdoor camera --1
- Indoor monitor --1
- Table charger for monitor --1
- Adaptor for outdoor camera --1
- Adaptor for indoor monitor --1
- DC Line for outdoor camera--1
- USB line for indoor monitor--1
- Lithium battery --2
- Screws --4

## 5. General faults and solutions

Fault	Cause(s)	Solution(s)
Can not start up	Neglected to press switch button	Press switch button
	Lithium battery is not installed	Install lithium battery
	Low battery	Charge up lithium battery
	No connection to power adapter when battery runs out	Connect to power adapter
Can not charge	Adapter connector doesn't connect to charging port of machine correctly	Reconnect correctly
	Adapter doesn't connect to 110V--240V alternating current	Plug into the socket to connect to alternating current
Outdoor unit cannot call or connect to Indoor monitor	Code match failed	Clear code, and re-match code
Image has noisy point or flickers	Handset is placed near to TV player, microwave oven, daylight lamp or mobile phone which produces electromagnetic wave interference.	Keep handset far away from the interference items
No signal for Indoor monitor	Outdoor unit doesn't connect to the power	Connect to the power
	Distance between outdoor unit and Indoor monitor is too far	Adjust to appropriate distance
	Disturbed by magnetic field around	Keep handset far away from magnetic field.

